

MOD
interiors

CP1709D

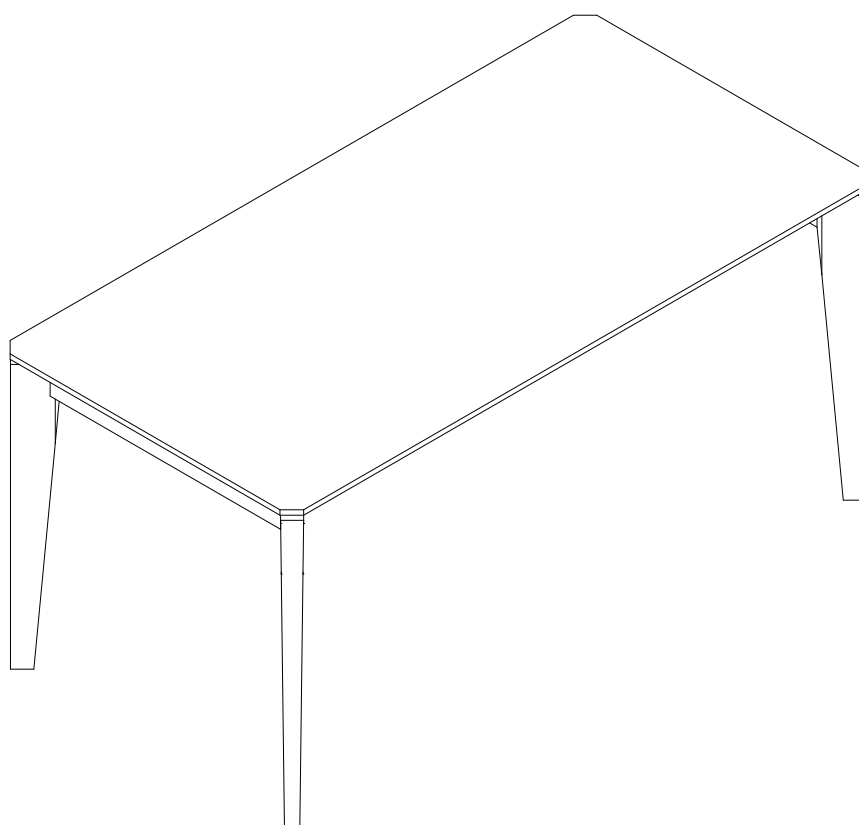

EAC

CP1709D

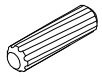
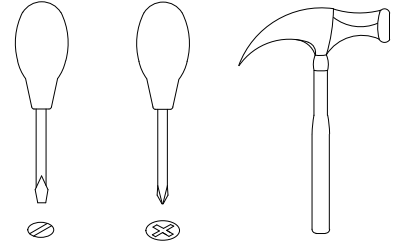
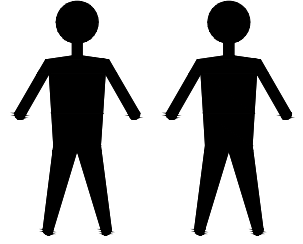

A x8
Spec: $\varnothing 8 \times L30$

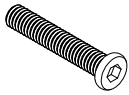

C x12
Spec: 5/16*45



D x12
Spec: $\varnothing 8 \times \varnothing 14$

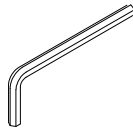

E x1
Spec: 5#



F x4
Spec: M8*L95

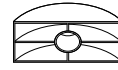

G x4
Spec:



H x4
Spec: M8



I x4
Spec: $\varnothing 38$

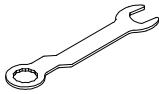

J x1
Spec: 14#

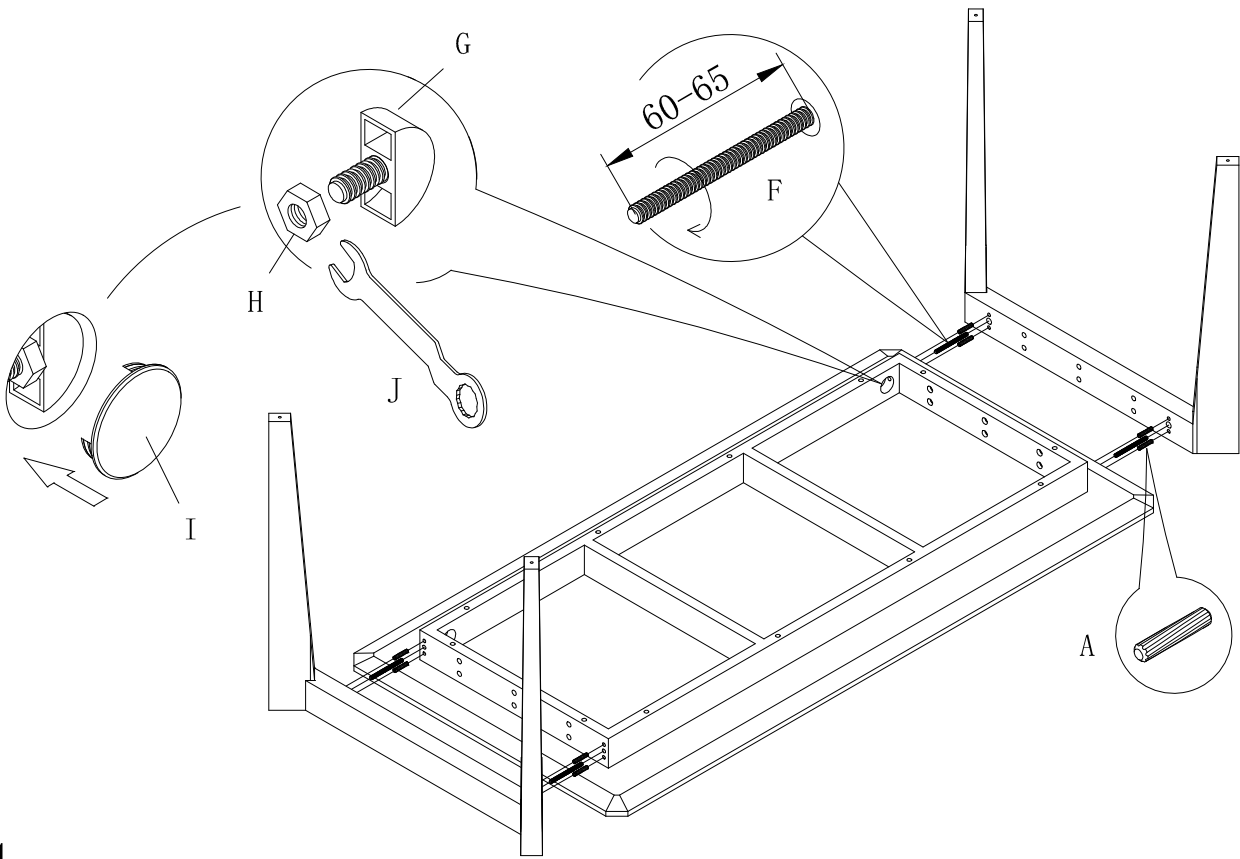

2

