

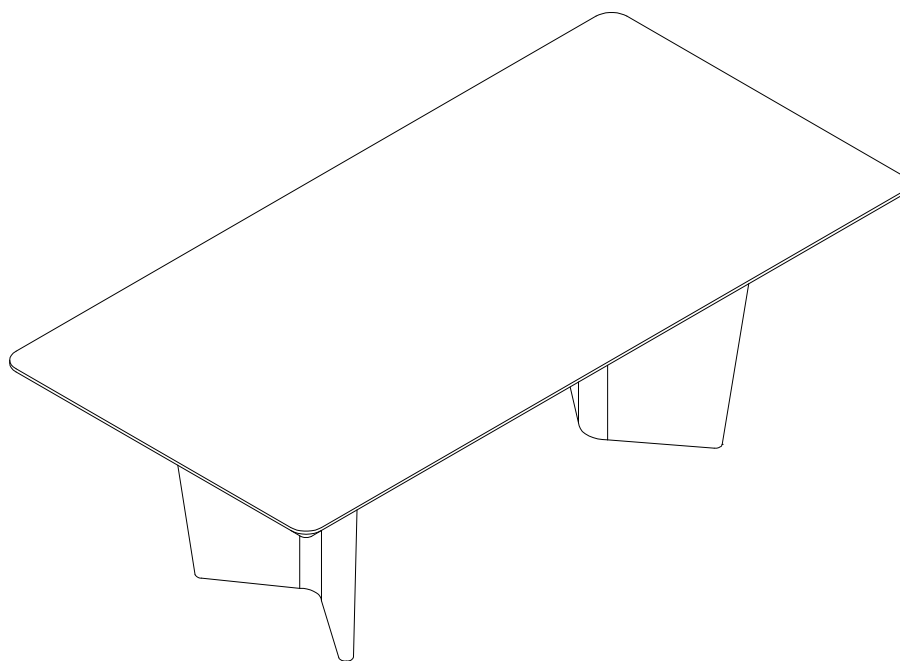

CP1908G



EAC

CP1908G

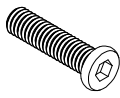
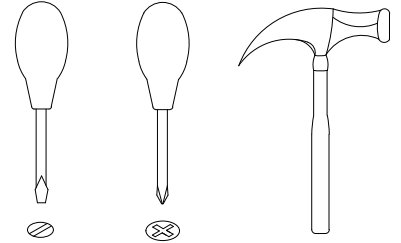
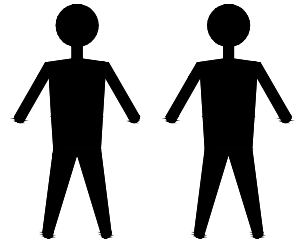

A x16
Spec: 5/16*L20



B x16
Spec: M14*8.2

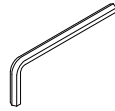

C x1
Spec: 5#

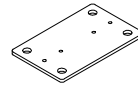

D x4
Spec: 160*100*5

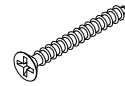

F x16
Spec: ϕ 3.8*L25

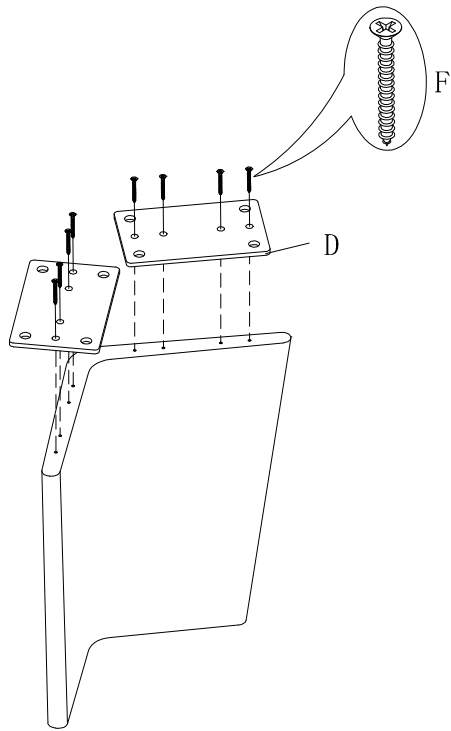

1

2

